

The following page(s) are extracted from multi-page Kuhnke product catalogues or CDROMs and any page number shown is relevant to the original document. The PDF sheets here may have been combined to provide technical information about the specific product(s) you have selected.

Hard copy product catalogues, and CDROMs have been published describing Kuhnke Pneumatics, Solenoids, Relays and Electronics; some divided into different books. A list of current publications is available on this web site or from our sales offices. Some may be available for download, but as substantially larger files.

Contact Details

Kuhnke sales and service in the UK

H. Kuhnke Ltd
Unit 21, Abbey Enterprise Center
Premier Way
Romsey
Hants
SO51 9AQ

T: 01794 514445

F: 01794 513514

Email: sales@kuhnke.co.uk

Important Note

The information shown in these documents is for guidance only. No liability is accepted for any errors or omissions. The designer or user is solely responsible for the safe and proper application of the parts, assemblies or equipment described.

Directional Control Valves (5/2), Solenoid Operated, ISO

Valves are constructed to the European ISO standard permitting interchangeability between manufacturers. ISO valves have a standard mounting configuration. Valves are also available with a European automotive standard coil configuration (CNOMO).

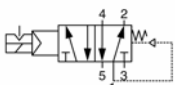
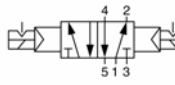
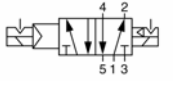
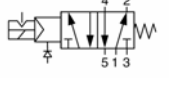
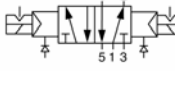
Description	Size	Type	Catalogue Number	
			Poppet Design	Spool Design
Single Solenoid Spring Return- air assisted 	ISO-1	Outboard coil	76087-91-00	76083-91-00
		Coil on top	76087-94-00	76083-94-00
		CNOMO Coil	76087-97-00	76083-97-00
	ISO-2	Outboard coil	--	--
		Coil on top	--	--
		CNOMO Coil	76097-97-00	76093-97-00
Double Solenoid With Detent 	ISO-1	Outboard coil	76087-92-00	76083-92-00
		Coil on top	76087-95-00	76083-95-00
		CNOMO Coil	76087-98-00	76083-98-00
	ISO-2	Outboard coil	--	--
		Coil on top	--	--
		CNOMO Coil	76097-98-00	76093-98-00
Double Solenoid With Priority Detent 	ISO-1	Outboard coil	--	--
		Coil on top	76087-96-00	--
		CNOMO Coil	--	--
	ISO-2	Outboard coil	--	--
		Coil on top	--	--
		CNOMO Coil	--	--
Single Solenoid External Air Pilot * Spring Return 	ISO-1	Outboard coil	--	--
		Coil on top	--	--
		CNOMO Coil	76387-97-00	76383-97-00
	ISO-2	Outboard coil	76397-97-00	76393-97-00
		Coil on top	--	--
		CNOMO Coil	--	--
Double Solenoid External Air Pilot * Detent 	ISO-1	Outboard coil	--	--
		Coil on top	--	--
		CNOMO Coil	76387-98-00	--
	ISO-2	Outboard coil	--	76393-98-00
		Coil on top	--	--
		CNOMO Coil	--	--

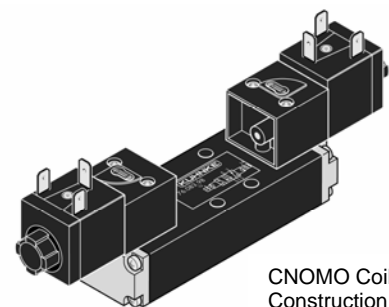
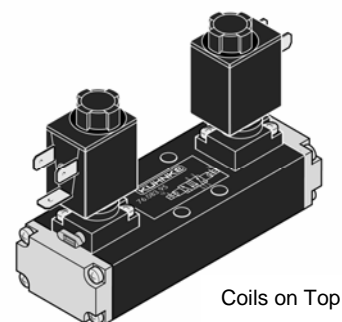
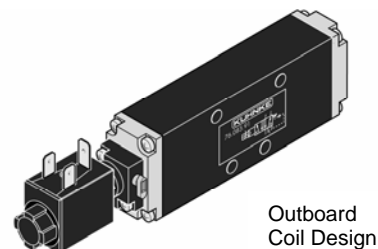

Order Coils Separately

Valve catalogue numbers do not include solenoid coils. Coils are supplied loose and unmounted as separate items. (Double solenoid types require 2 coils.)

Std. AC Coil Cat. No. 76410-02-**
Std. DC Coil Cat. No. 76410-00-**
CNOMO AC Coil Cat. No. 76411-02-**
CNOMO DC Coil Cat. No. 76411-00-**

** - Add the required coil voltage suffix code from the chart below to complete the coil catalogue number.

<u>Voltage</u>	<u>AC</u>	<u>DC</u>
12V	-	01
24V	12	02
48V	13	03
110V	14	04
230V	15	05

*External Air Pilot: valves have an auxiliary port for connecting a separate air pilot supply for the solenoid section. Use when switching air pressures below 2.5 bar.

For technical details of ISO valves contact factory. See accessory section for manifolds and sub bases.